



Constant Current CoB Series

Product Data Sheet



Table of Contents

Introduction	3
1.1 Features	3
1.2 Benefits	3
1.3 Mechanical Dimension	4
1.4 Product Nomenclature	4
Performance Characteristics	5
2.1 Product Selection Guide	5
Performance Characteristics	6
2.2 Electrical Characteristics	6
2.3 Color Binning Information	7
2.4 Absolute Maximum Ratings	8
Performance Curves	9
3.1 Characteristic Curves	9
3.2 Optical Curves	10
3.3 The Relative Spectral Distribution Graph	11
Reliability Test	12
Packaging and Labeling	13
Precautions	14
About Xdlumen	15

Introduction

Xdlumen CoB LED array products deliver high quality light in a compact and cost-effective solid state lighting package. Our advanced packaging technology and private phosphor combination has excellent reliability. Lighting system designs incorporating these LED arrays deliver increased system level efficacy and longer service life.

Our Constant Current CoB series cover a wide range of luminous from 5W to 20W lamp for general lighting, automotive lighting and other special applications. The CoB LED array is also available in a variety of CCT and CRI combinations providing substantial design flexibility and energy efficiency.

Xdlumen CoB LEDs are tested at 25°C, luminaire design can be simplified and testing can be minimized.

1.1 Features

- Efficacy of 85lm/W typical for 3000K, 90CRI
- Compact high flux density light source
- Uniform, high quality illumination
- Minimum 90, and Typical 97 CRI options
- StreaCLined thermal path
- ENERGY STAR® / ANSI compliant color binning structure with 2, 3 and 5 SDCM standard
- More energy efficient than incandescent, halogen and fluorescent lamps
- High voltage or Low voltage DC operation
- Product series and company logo on the front
- RoHS compliant

1.2 Benefits

- Enhanced optical control no stroboscopic
- PWM dimming High quality, true color reproduction
- Significantly reduced thermal resistance and increased operating temperature
- Linearity control Uniform, consistent white light
- Lower operating cost
- Easy to use with daylight and motion detectors to enable increased energy saving
- Reduced maintenance cost
- Environmentally friendly, no disposal issue

1.3 Mechanical Dimension

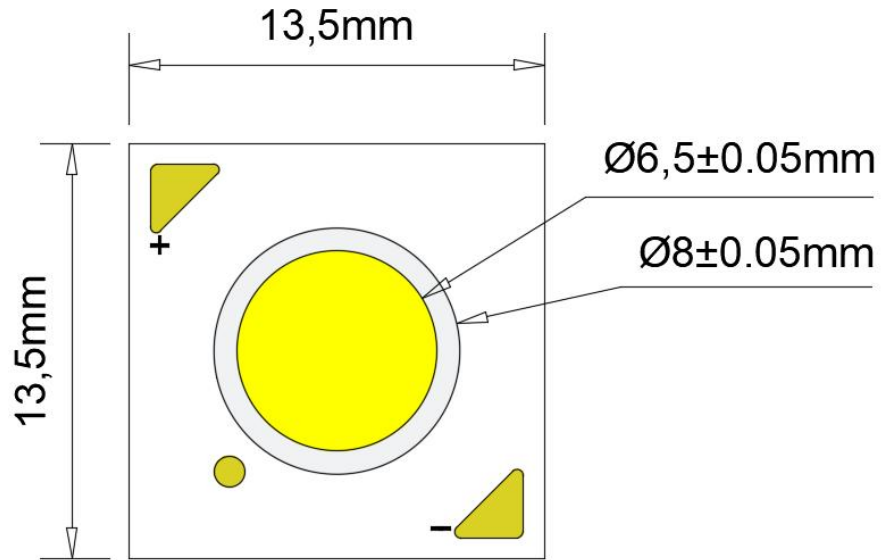

Notes:

1. All dimension tolerance is $\pm 0.2\text{mm}$ unless otherwise noted.

1.4 Product Nomenclature

The part number designation for Xdlumen High Lumen Density Series LED arrays is explained as follows:

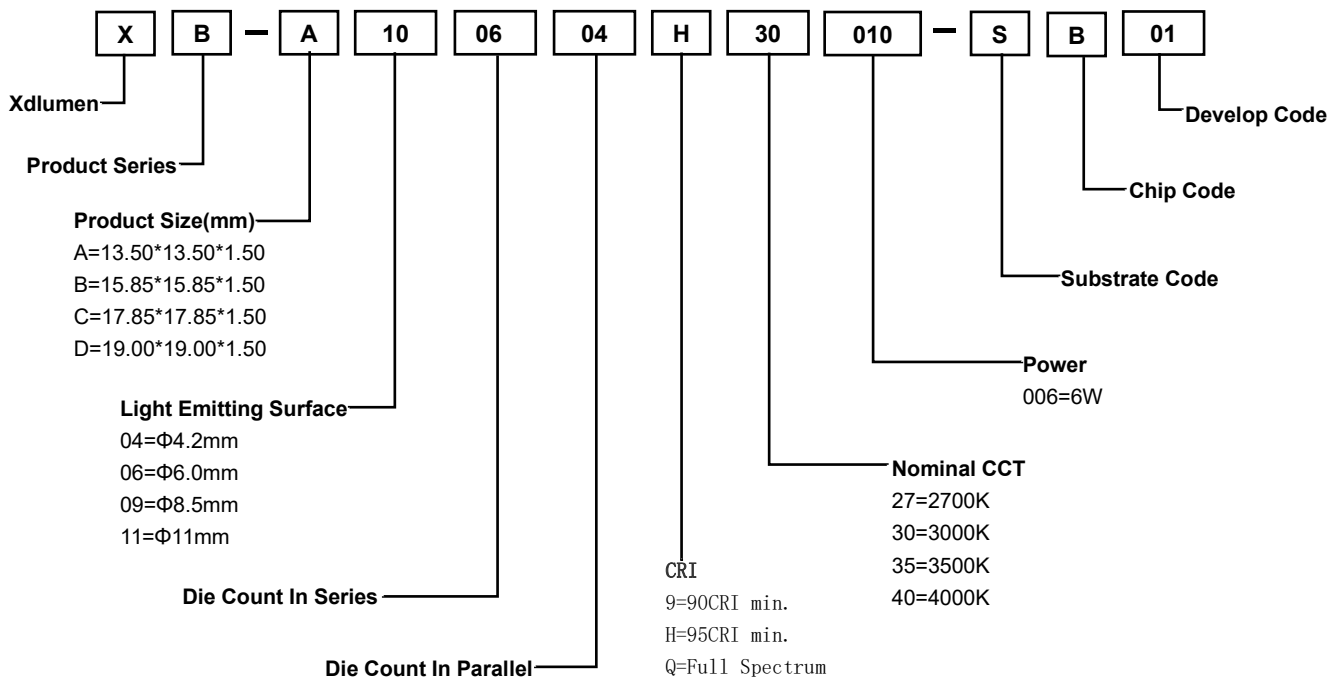

Performance Characteristics

2.1 Product Selection Guide

Table 1: Electro-Optical Characteristics at Tc=25°C

Part Number	Typical Power (W)	Nominal CCT (K)	CRI	Minimum R9	Minimum Pulsed Flux (lm)	Typical Pulsed Flux (lm)	Typical Voltage (V)	Nominal Current (mA)	Typical Efficacy (lm/W)
XB-B060703927015AJ01	14.4	2700 K	90	50	1000	1119	24	600	81
XB-B060703930015AJ01	14.4	3000 K	90	50	1000	1142	24	600	85
XB-B060703935015AJ01	14.4	3500 K	90	50	1050	1200	24	600	90
XB-B060703940015AJ01	14.4	4000 K	90	50	1050	1211	24	600	92
XB-B060703950015AJ01	14.4	5000 K	90	50	1050	1220	24	600	95

Notes for Table 1:

1. Nominal CCT as defined by ANSI C78.377-2015.
2. Products tested based on operation under DC(Direct current) with LED array mounted onto a heat sink with thermal interface material and T_c (case temperature) = 25°C. Base on Xdlumen test set up, values also depending on the thermal design and exposed environment to which the luminaire is subjected.
3. Typical performance values are provided as a reference only and are not a guarantee of performance.
4. Xdlumen maintains a $\pm 7\%$ tolerance on flux measurements. $\pm 3\%$ tolerance on voltage measurements. ± 2 Ra tolerance on Ra measurements.
5. Alternate drive currents are provided for reference only and are not a guarantee of performance

Performance Characteristics

2.2 Electrical Characteristics

Table 2: Electrical Characteristics

Part Number	Drive Voltage (V)	Forward Current Pulsed, T _c = 25°C (mA)			Typical Coefficient Of Forward Voltage $\Delta V_f / \Delta T_c$ (mV/°C)	Typical Thermal Resistance Junction to Case R _{j-c} (°C/W)
		Minimum	Typical	Maximum		
XB-B060703930015AJ01	24	---	600	---	-16	1.57

Notes for Table2:

1. Parts are tested in pulsed conditions, T_c = 25°C. Pulse width is 10ms.
2. Voltage minimum and maximum are provided for reference only and are not a guarantee of performance.
3. Xdlumen maintains a tester tolerance of ± 0.10V on forward voltage measurements.
4. Typical coefficient of forward voltage tolerance is ± 0.1mV for nominal current.
5. Thermal resistance values are based from test data of a 3000K 90 CRI product.
6. Thermal resistance value was calculated using total electrical input power; optical power was not subtracted from input power. The thermal interface material used during testing is not included in the thermal resistance value.
7. Vf min hot and max cold values are provided as reference only and are not guaranteed by test. These values are provided to aid in driver design and selection over the operating range of the product.

2.3 Color Binning Information

Figure 1: Graph of Test Bins in CIE1931xy Color Space (Pulsed Test Conditions, $T_c = 25^\circ\text{C}$)

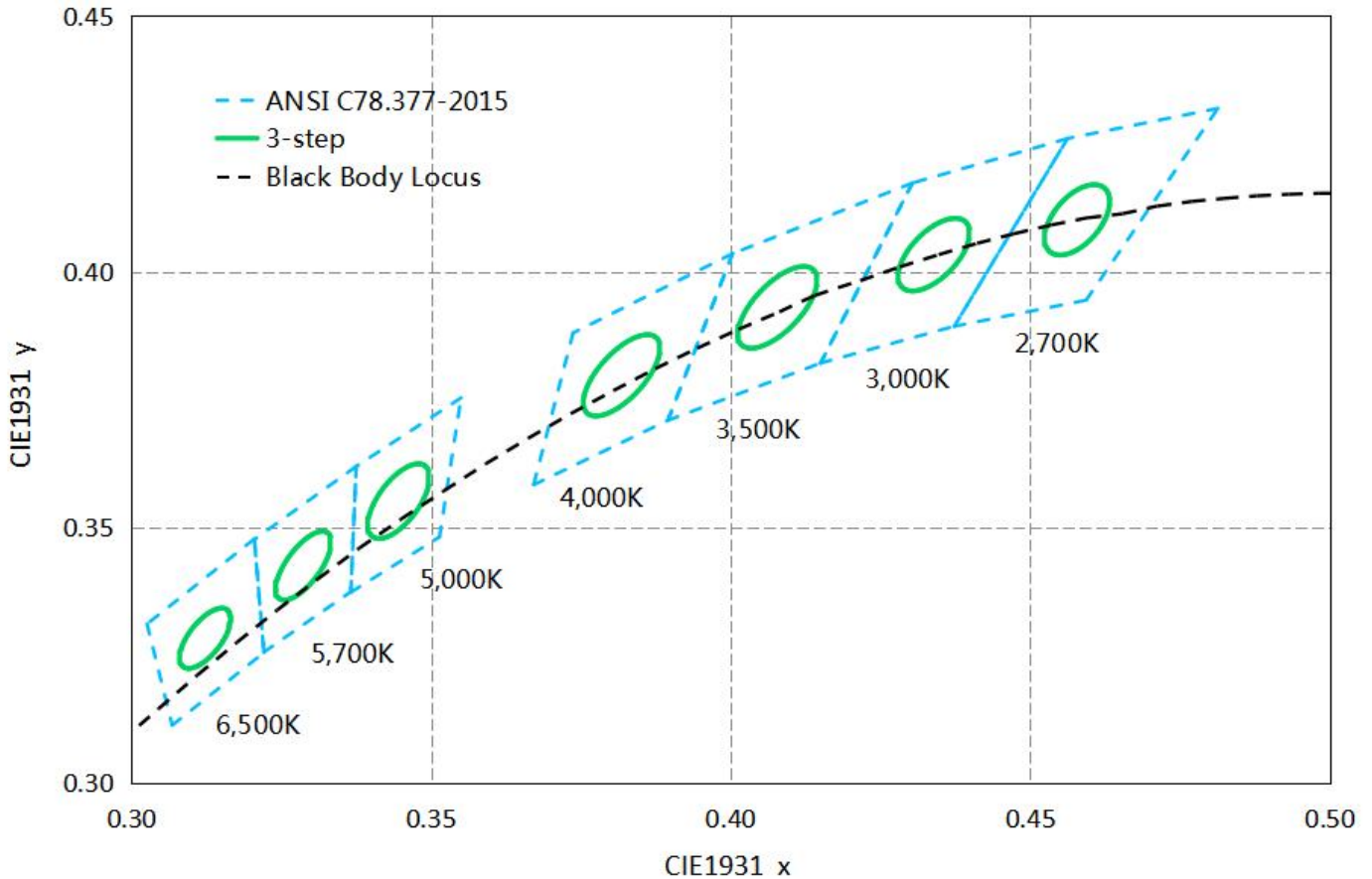

Table 3: 3-step MacAdam ellipse color bin definitions for Xdlumen CoB Core Range

Nominal CCT	Center Point		MAJOR AXIS (a , b)		Ellipse Rotation Angel, θ
	X	Y	3-Step	5-Step	
2700K	0.4578	0.4101	(0.00810 0.00420)	(0.01350, 0.00700)	53.70
3000K	0.4338	0.4030	(0.00834, 0.00408)	(0.01390, 0.00680)	53.22
3500K	0.4073	0.3917	(0.00927 0.00414)	(0.01545, 0.00690)	54.00
4000K	0.3818	0.3797	(0.00939, 0.00402)	(0.01565, 0.00670)	53.72
5000K	0.3447	0.3553	(0.00822, 0.00354)	(0.01370, 0.00590)	59.62
5700K	0.3287	0.3417	(0.00747, 0.00321)	(0.01245, 0.00535)	59.09
6500K	0.3123	0.3282	(0.00669, 0.00285)	(0.01115, 0.00475)	58.57

Note for Table 3:

Xdlumen maintains a tolerance of ± 0.005 on x and y coordinates in the CIE 1931 color space.

Performance Characteristics

2.4 Absolute Maximum Ratings

Table 4: **Maximum Ratings**

Parameter	Maximum Rating
LED Junction Temperature (T_j)	150°C
Storage Temperature	-40 ~ +105°C
Operating Case Temperature1 (T_c)	105°C
Soldering Temperature	350°C or lower for a maximum of 6 seconds
Electrostatic Discharge (HBM)	2000V
Maximum Drive Current	600mA
Maximum Peak Pulsed Drive Current	600mA
Maximum Reverse Voltage	Xdlumen LEDs are not designed to be driven in reverse bias

Notes for Table 4:

1. Driven the arrays at higher currents however lumen maintenance may be reduced.
2. Proper current derating must be observed to maintain junction temperature below the maximum
3. Pulsed operation with a peak drive current equal to the stated peak pulsed forward current is acceptable if the pulse on-time is $\leq 1\text{ms}$ per cycle and the duty cycle is $\leq 10\%$
4. Light emitting diodes are not designed to be driven in reverse voltage and will not produce light under this condition. Maximum rating provided for reference only.

Color Binning Information

Performance Curves

3.1 Characteristic Curves

Figure 2: **Relative Luminous Flux Vs. Forward Current**

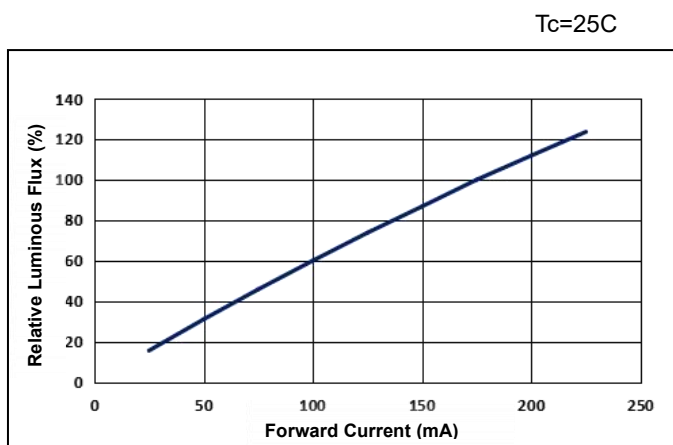

Figure 3: **Forward Current vs. Forward Voltage**

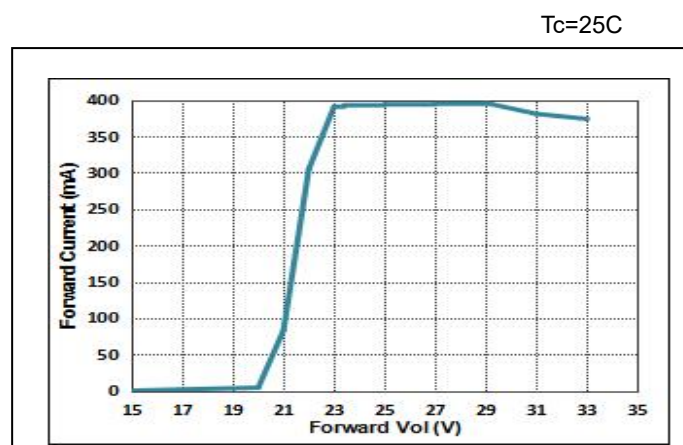

Figure 4: **Forward Voltage Vs. Case Temperature**

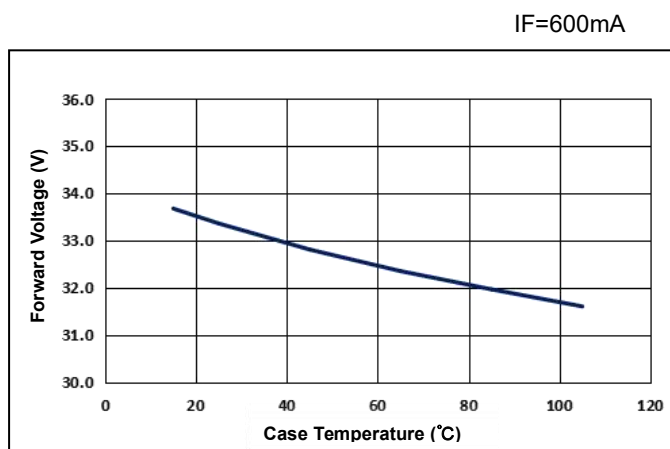
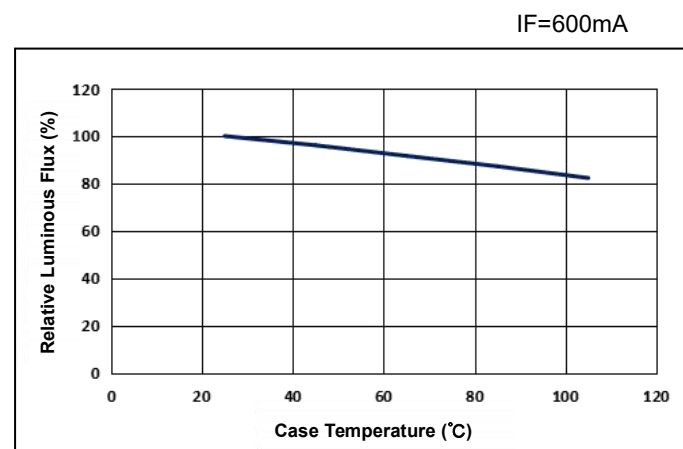

Figure 5: **Relative Luminous Flux vs. Case Temperature**



Notes for Figures 2-5:

1. Xdlumen does not recommend driving our LED arrays at low currents. Doing so may produce unpredictable results.
2. Products tested based on operation under DC(Direct current) with LED array mounted onto a heat sink with thermal interface material and Tc (case temperature) = 25°C. Base on Xdlumen test set up, values also depending on the thermal design and exposed environment to which the luminaire is subjected.

3.2 Optical Curves

Figure 6: Typical Spatial Radiation Pattern

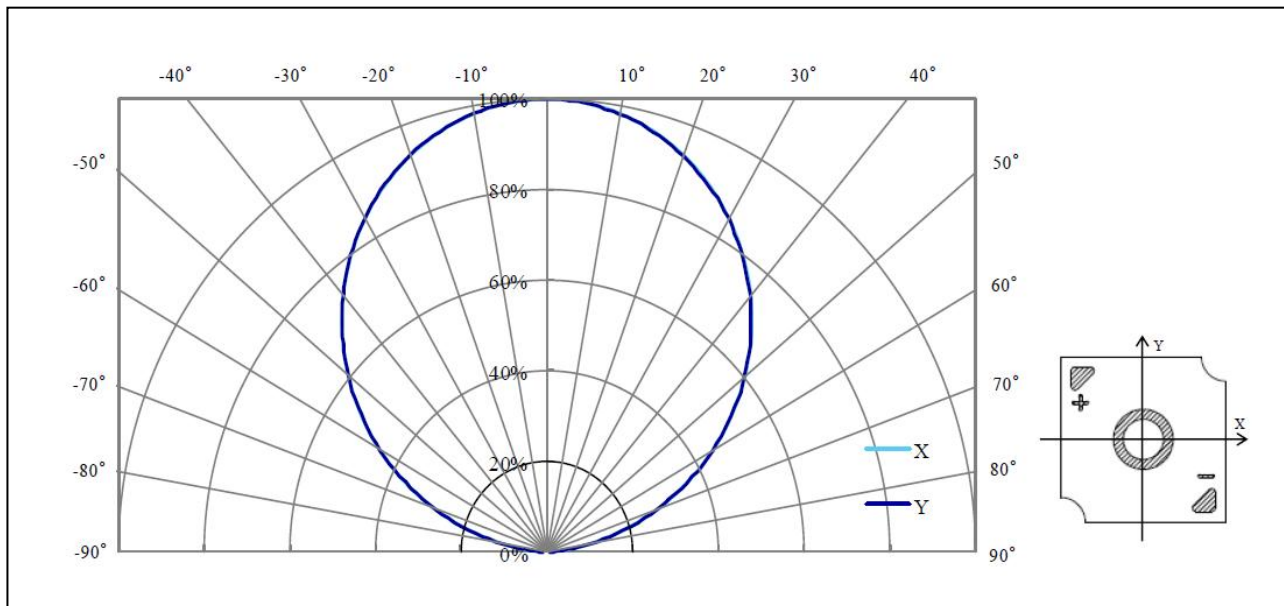
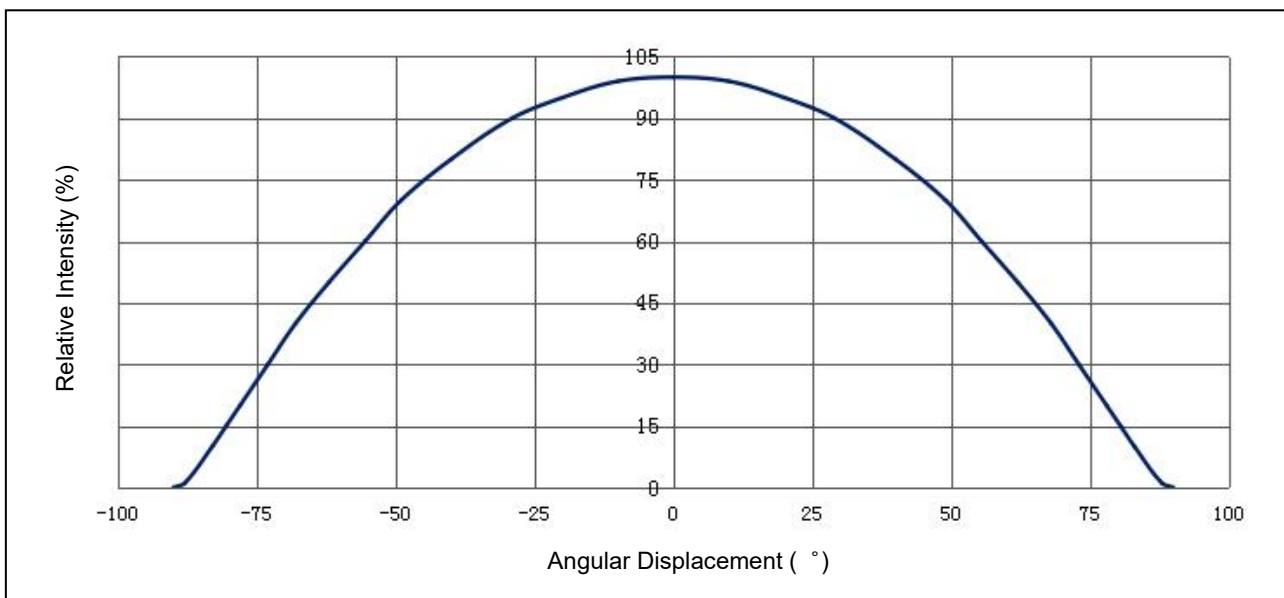

Figure 7: Typical Polar Radiation Pattern



Note for Figure 6 & 7:

1. Typical viewing angle is 120°.
2. The viewing angle is defined as the off axis angle from the center line where intensity is 1/2 of the peak value.

3.3 The Relative Spectral Distribution Graph

Figure 8: Typical Color Spectrum for 90CRI

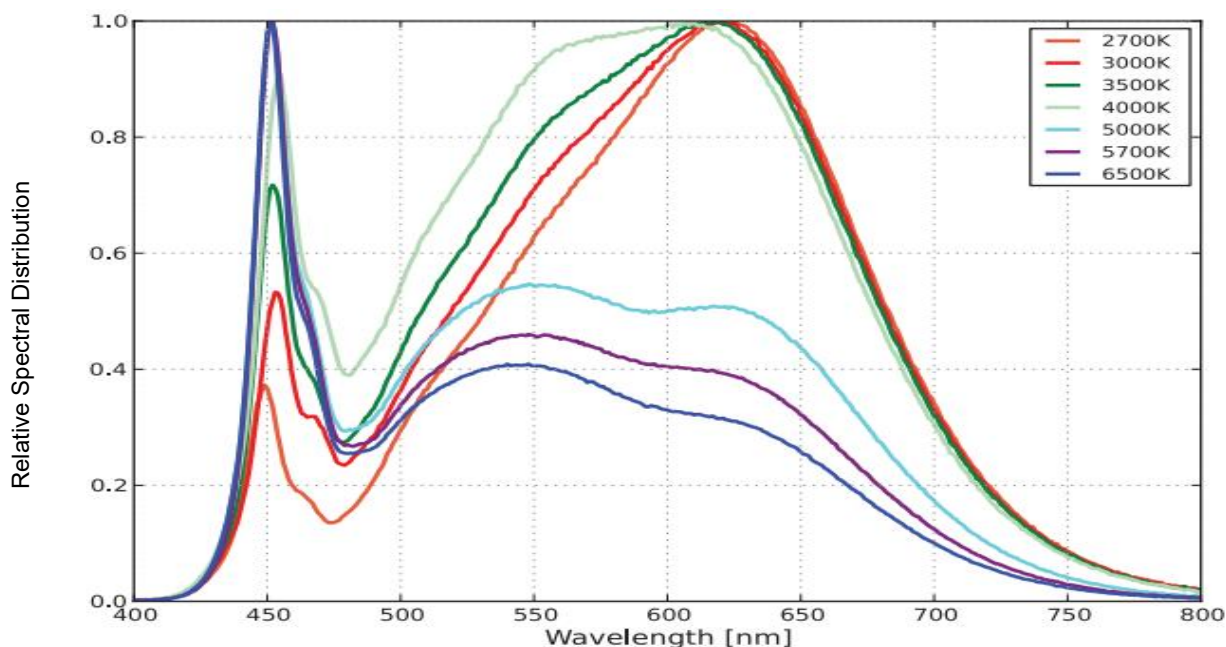

Note for Figure 8:

1. Color spectra measured at nominal current for $T_j = T_c = 25^\circ\text{C}$.
2. Color spectra shown is 2700K 、3000K、3500K、4000K and 90 CRI.

Figure 9: Typical Color Spectrum for 95CRI

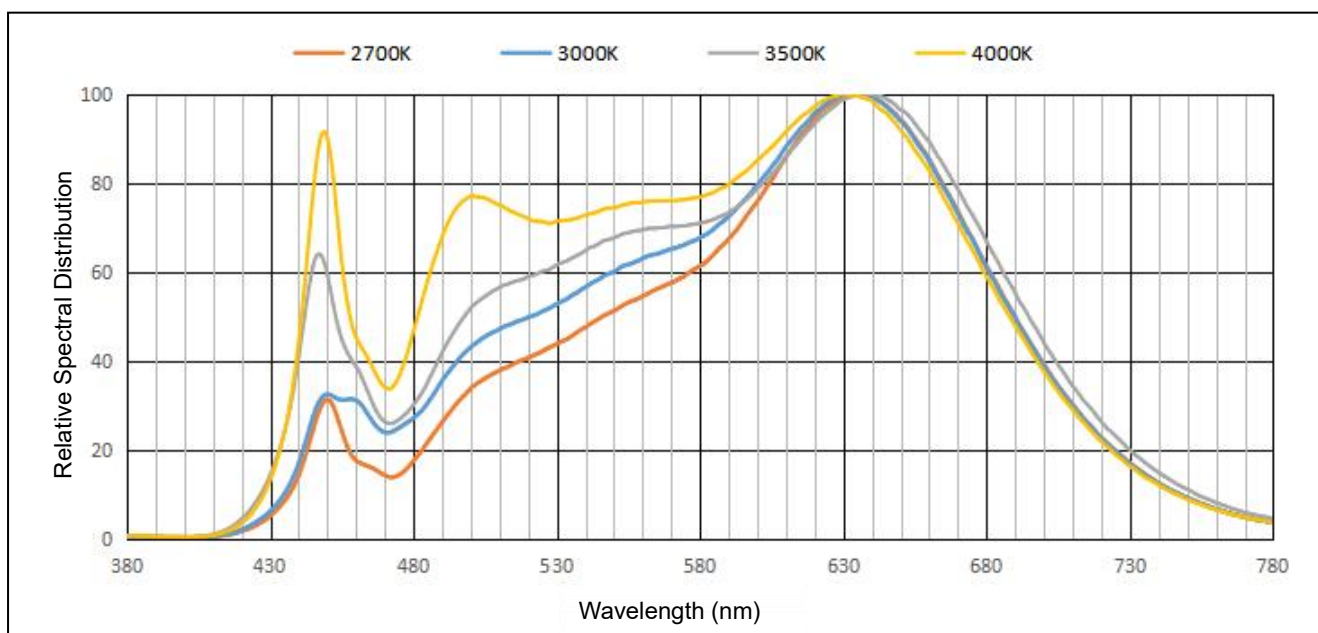

Note for Figure 9:

1. Color spectra measured at nominal current for $T_j = T_c = 25^\circ\text{C}$.
2. Color spectra shown is 2700K 、3000K、3500K、4000K and 95 CRI.

Reliability Test

Table 5: Reliability Test Items And Conditions

Test Items	Ref. Standard	Test Conditions	Sample Quantity	Failure Quantity
Thermal Shock	JESD22-A106	-40°C(15min) ~ 100°C(15min), 200 cycles	10	0
High Temperature Storage	JESD22-A103	Ta=105°C, 1000h	10	0
Low Temperature Storage	JESD22-A119	Ta=-40°C, 1000h	10	0
High Temperature High Humidity Life Test	JESD22-A101	Ta=85°C, RH=85%, IF=175mA 1000h	10	0
High-Temperature Life Test	JESD22 -A108	Ta=105°C, IF=175mA 1000h	10	0
Low-Temperature Life Test	JESD22 -A108	Ta=-40°C, IF=175mA 1000h	10	0

Table 6: Failure Criteria

Measuring Item	Symbol	Measuring Conditions	Failure Criteria
Forward Voltage	VF	IF=600mA	>U × 1.1
Total Luminous Flux	Φv	IF=600mA	<S × 0.85

Notes for Table 6:

1. Proper current derating must be observed to maintain junction temperature below the maximum
2. Measurement shall be taken between 2 hours and 24 hours, and the test pieces should be return to the normal ambient conditions after the completion of each test.

Packaging and Labeling

Figure 10: Product Packing and Labeling

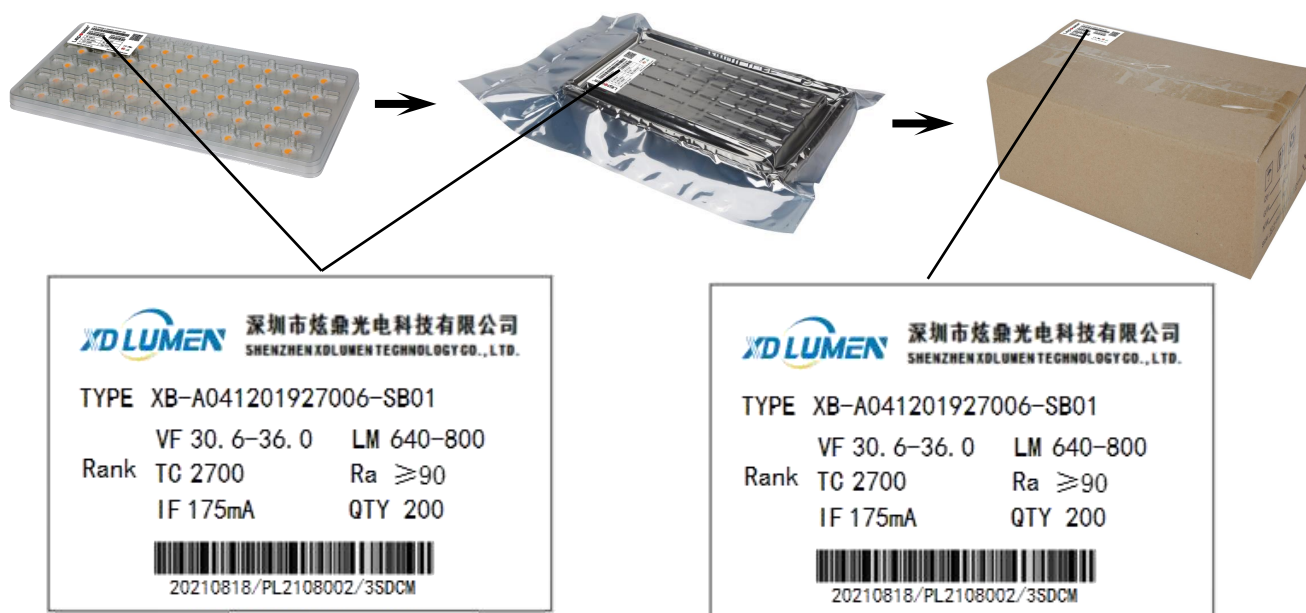

Notes for Figure 10:

1. Each tray holds 50 CoBs.
2. The top tray is to be labeled as shown above.

Figure 11: Product Labeling

Xdlumen CoB has a product label outside of the plastic box. Besides the external label, Xdlumen CoB light source has laser tag on the back to help the product identification

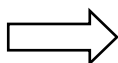
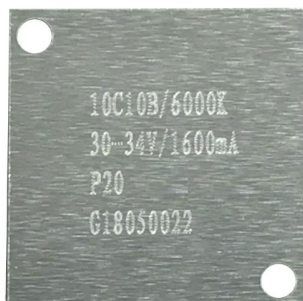

Chip distribution / CCT
VF Bin / Test Current
Chip Part Number
Work Order Number

Precautions

CAUTION

RECOMMENDED SOLDERING CONDITION

For manual soldering. Please use lead-free soldering and the soldering shall be implemented using a soldering bit at a temperature lower than 350C, and shall be finished within 3.5 seconds for one land. No external force shall be applied to resin part while soldering is implemented. Next process of soldering should be carried out after the product has return to ambient temperature.

CAUTION: TEMPERATURE CONTROL

Suggested Temperature on Tc	Suggested Temperature on the center of Emitting diameter:
$T_c = T_{J-C} - (R_{j-c} * P_i)$ $T_{J-C} \leq 125^\circ\text{C}$	Warm White LED <125°C Natural White LED <125°C Cool White LED <125°C

CAUTION: RISK OF STATIC ELECTRICITY

Handling of Xdlumen LED array needs countermeasures against static electricity because this is a semiconductor product. Please take adequate measures to prevent any static electricity being produced such as the wearing of a wristband or anti-static gloves when handling this product. Every manufacturing facility in regard to the product (plant, equipment, machine, carrier machine and conveyance unit) should be connected to ground and please avoid the product to be electric-charged. ESD sensitivity of this product is over 1000V (HBM, based on JEITA ED-4701/304). After assembling the LEDs into your final product(s), it is recommended to check whether the assembled LEDs are damaged by static electricity (electrical leak phenomenon) or not.

CAUTION: CHEMICAL EXPOSURE HAZARD

Exposure to some chemicals commonly used in luminaire manufacturing and assembly can cause damage to the LED array. Please consult Xdlumen Installation Instruction for additional information.

CONTACT WITH LIGHT EMITTING SURFACE (LES)

Avoid any contact with the LES. Do not touch the LES of the LED array or apply stress to the LES(yellow phosphor resin area). Contact may cause damage to the LED array. Optics and reflectors must not be mounted in contact with the LES (yellow phosphor resin area). Optical devices may be mounted on the top surface of the plastic housing of the Xdlumen LED array. Use the mechanical features of the LED array housing, edges and/or mounting holes to locate and secure optical devices as needed.

EYE SAFETY

Eye safety classification for the use of Xdlumen LED arrays is in accordance with specification IEC/TR 62778: Application of IEC 62471 for the assessment of blue light hazard to light sources and luminaires. We classify Lepower LED at 4000K qualified RG2 , Ethr= 1847.5 lx. At 5000K qualified RG2. Ethr= 1315.8 lx. At 6500K qualified RG2, Ethr= 1124.5 lx.

Please consult Xdlumen Installation Instruction for additional information.

About Xdlumen

Xdlumen is one of the leading experts manufacturer of high power LED in China. We committed to providing environmentally friendly products to the solid-state lighting mark. Xdlumen LEDs are compliant to the European Union directives on the restriction of hazardous substances in electronic equipment, namely the RoHS Directive 2011/65/EU and REACH Regulation (EC) 1907/2006. Let's make light excellent.

For more information about Xdlumen please visit:

www.xdlumen.com

Contact US

6th floor, Building H, Jinchangda Industrial Zone, Shangwei, Zhangkengjing, Guanhu street,
Longhua District, Shenzhen, China

Tel: +86-755-23775517

Fax : +86-755-23775517

www.xdlumen.com