

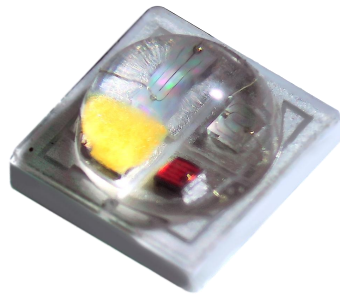

3535 Ceramics LED Series

Product Data Sheet



DESIGNED	CHECKED	APPROVED	CUSTOMER	REV.
2020.08.13	2020.08.13	2020.08.13		2020.08.13
QINYALI	ZHAOSHENGLI	HEYIDE		A02

Introduction

3535 RGBW Ceramics LED Series

The XDlumen 3535 RGBW Ceramics LED Series boasts the efficiency and reliability demanded by the spotlight market, high visibility, high stability and other requirements. It delivers optimized performance in combination with the Quality of Light needed for distributed light source applications in four performance levels. In addition to offering specified correlated color temperature and color rendering combinations, XDlumen 3535 RGBW series is available in Three products.

FEATURES AND BENEFITS

- ❖ Supports ENERGY STAR lumen maintenance certification requirements
- ❖ Low thermal resistance, Low Voltage, Superior Lumen, High light efficiency
- ❖ Full spectrum configurations for design flexibility
- ❖ ANSI color binning delivers tight color control
- ❖ According to McAdam spectroscopic color separation, SDCM<5
- ❖ Minimum color tolerance is less than 3 step

APPLICATIONS

General lighting

Spotlight

Specialty Lighting

目录

Typical Electrical & Optical Characteristics(T = 25°C).....	3rd
Typical Electrical Characteristics(T = 25°C).....	3rd
Absolute Maximum Rating(T = 25°C).....	4th
Part Number Nomenclature	5th
LED Classification standard	5th
VF bincode	6th
Lumen bincode	6th
Color Binning Information.....	7th
Typicalelectrical characteristic curve	6th
Product Packing Dimensions (Unit:mm)	9th
Solder Pad Design (Unit:mm)	9th
Product Packing (Unit:mm)	10th
Application notes	11th
SMT Reflow Soldering Instructions	14th
About Xdlumen	15th

Typical Electrical & Optical Characteristics(T = 25°C)

Item	Condition	Symbol	Min	Avg	Max	unit
Forward Current		I_f	---	150	600	mA
Reverse Current	5V	I_R	---	---	1	μ A
View Angle		$\Theta 1/2$		120		°
R-Wd			----	624.2	----	nm
G-Wd		WD	----	522.2	----	nm
B-Wd			----	458.0	----	nm
W-TC	150mA*4		----	6500	----	K
IV-R			----	20.29	----	lm
IV-G		φ	----	40.64	----	lm
IV-B			----	9.64	----	lm
IV-W			----	62.45	----	lm

Typical Electrical Characteristics(T = 25°C)

Item	Condition	Symbol	Min	Avg	Max	unit
Forward Voltage (R)	150mA		2.0	2.11	2.3	V
Forward Voltage (G)	150mA	V_f	2.5	2.67	2.9	V
Forward Voltage (B)	150mA		2.5	2.71	2.9	V
Forward Voltage (W)	150mA		2.7	2.86	3.1	V

1.xdlumen maintains a tolerance of $\pm 0.03V$ on forward voltage measurements

2.Measured by 25°C .Pulse test

Absolute Maximum Rating(T = 25°C)

Items	Symbol	Absolute maximum Rating	Unit
Forward Current	I_F	150	mA
Pulse Forward Current	I_m	600	mA
Inverse voltage	V_R	5	V
Consumed Power	P_D	430	mW
Operation Temperature	T_{opr}	-40 to + 100	°C
Storage Temperature	T_{stg}	-40 to + 100	°C
Junction temperature	T_j	125	°C
Junction To Solder Pad	R_{th}	28	°C/W
ESD Sensitivity	V	2000	V
Soldering Temperature	T	255 (JEDEC 020D)	°C
Allowable Reflow Cycles	Times	2	T
Intersection Temperature	T	80	°C

- 1、 Proper current derating must be observed to maintain the junction temperature below the maximum allowable junction temperature
- 2、 Residual periodic variations due to power conversion from alternating current (AC) to direct current (DC), also called “ripple,” are acceptable if the following conditions are met:
 - The frequency of the ripple current is 100Hz or higher
 - The average current for each cycle does not exceed the maximum allowable DC forward current
 - The maximum amplitude of the ripple does not exceed the maximum peak pulsed forward current
 - At 10% duty cycle with pulse width of 10ms.
 - Proper current derating must be observed to maintain the junction temperature below the maximum allowable junction temperature.

Part Number Nomenclature

The part number designation for Xdlumen High Lumen Density Series LED arrays is explained as follows:

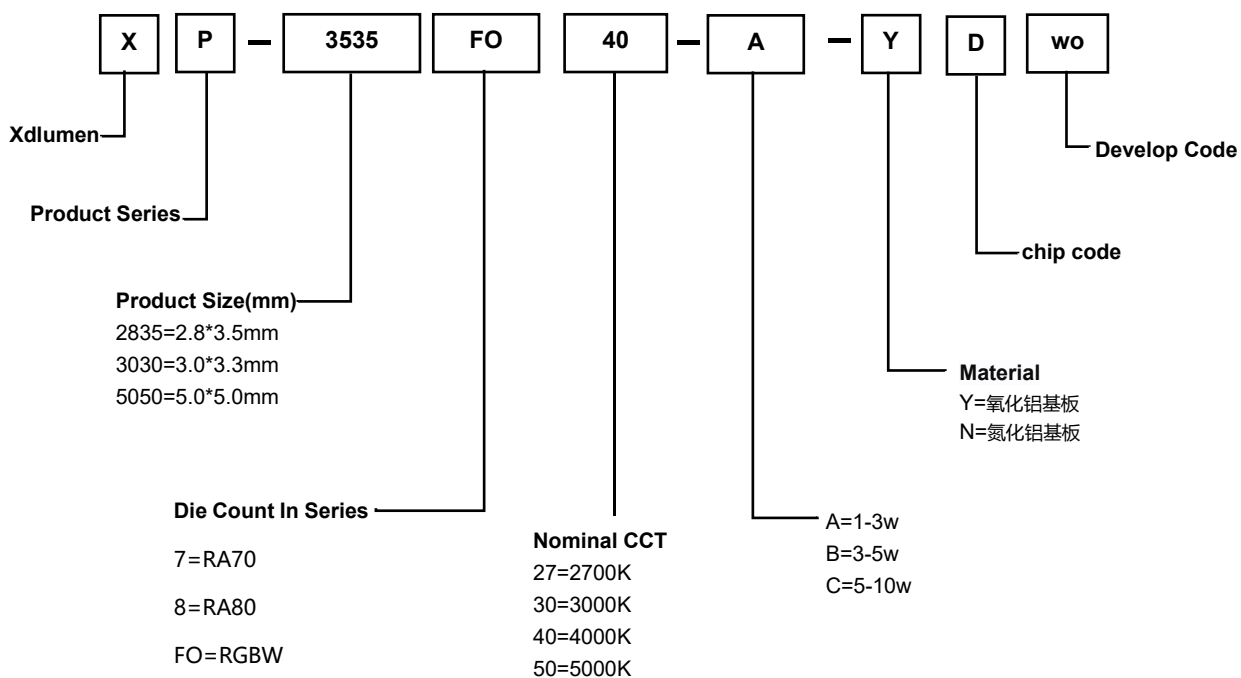
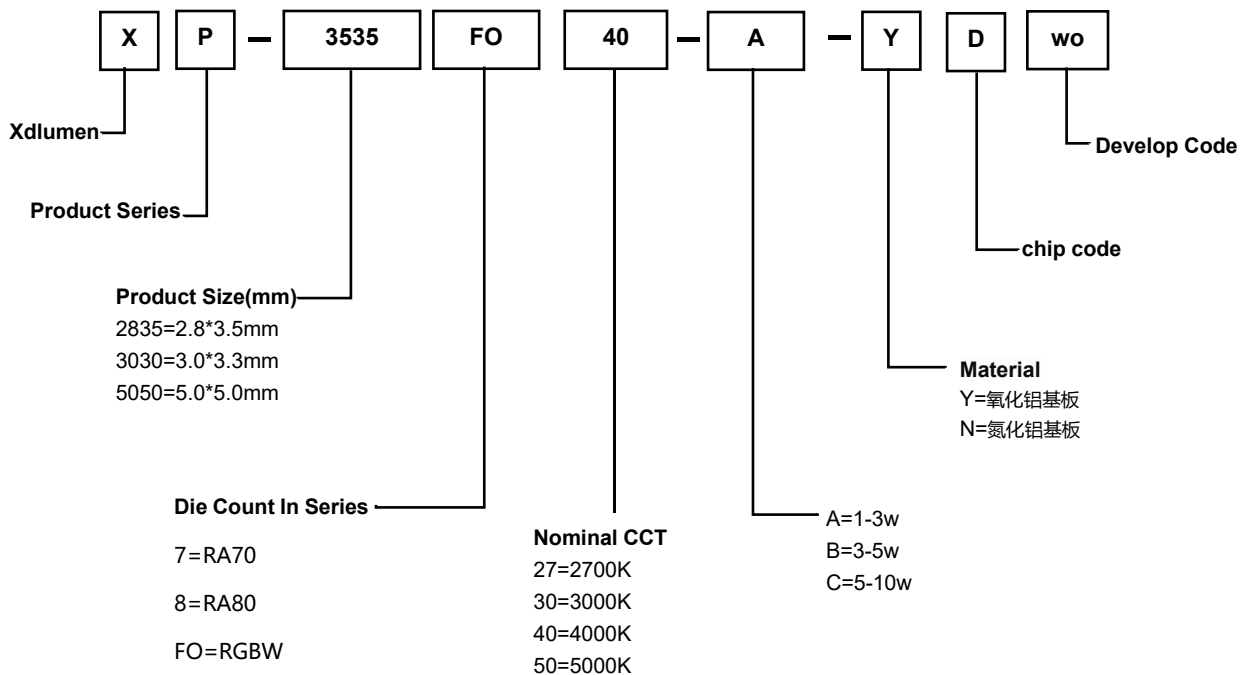

LED Classification standard

VF bincode

Symbol	VF (V)	
	MIN	MAX
R	2.0	2.8
G	2.5	2.9
B	2.5	2.9
W	2.7	3.1

Lumen bincode

Symbol	Flux(lm)		
	MIN	AVG	MAX
R	----	20.29	----
G	----	40.64	----
B	----	9.64	----
W	----	62.45	----

1. Test conditions is $I_F=150\text{mA}$, 25°C ;

2. The error value of λ_d is $\pm 0.5\text{nm}$

3. IV Lumen error value is $\pm 0.3\text{lm}$

4. The lumen error of different integrating spheres is about $\pm 5\%$

5. Vf min hot and max cold values are provided as reference only and are not guaranteed by test. These values are provided to aid in driver design and selection over the operating range of the product.

Color Binning Information

On the basis of $SDCM \leq 3$ incutting, shipment is divided into four pins: A1,A2,B1 and B2 to ensure the consistency of light color.

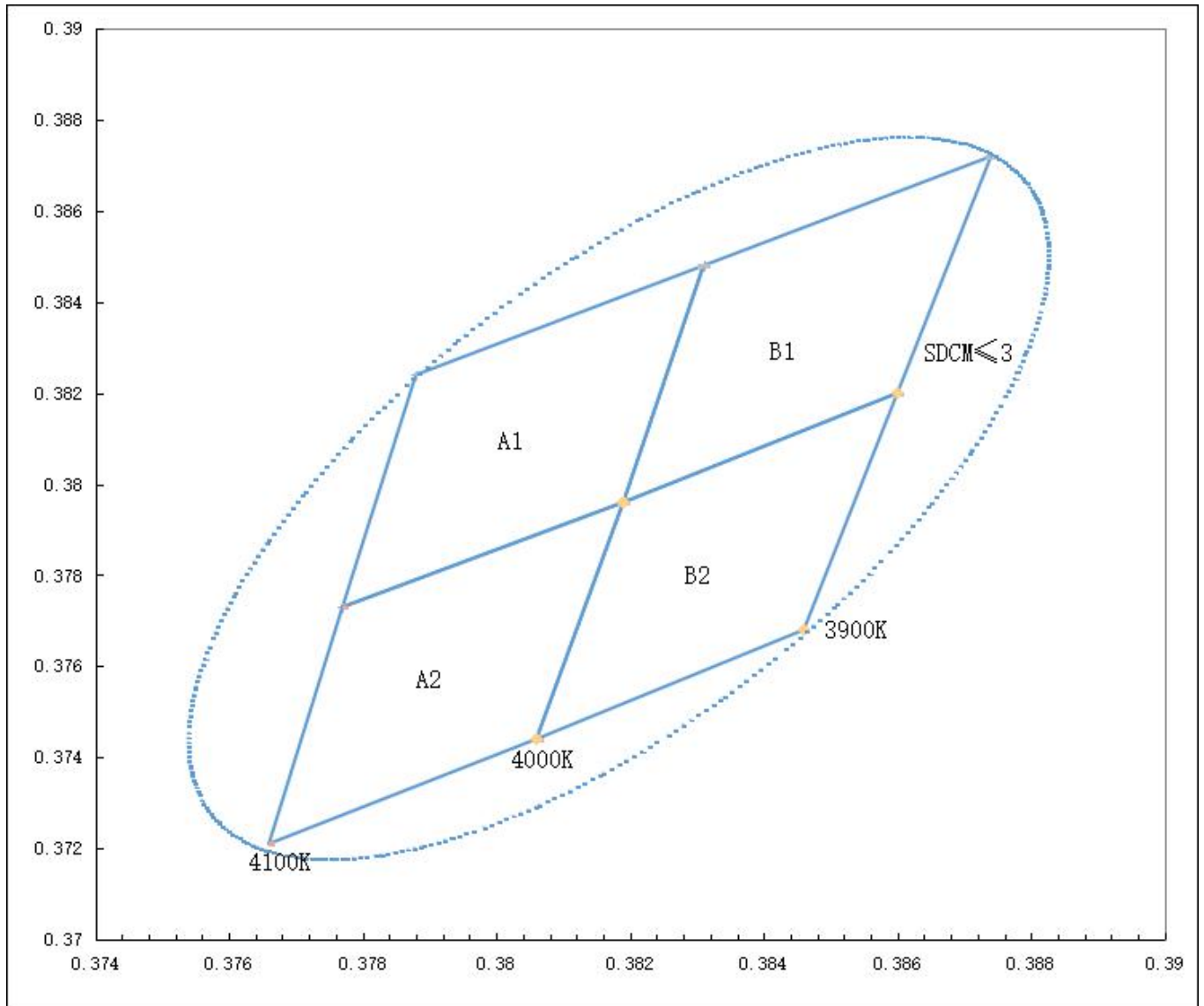

1. The error value of X and Y in the color region is ± 0.001

2. Test conditions is IF=150mA, 25°C

Typicalelectrical characteristic curve

Figure3. Typical forward current vs. forward voltage

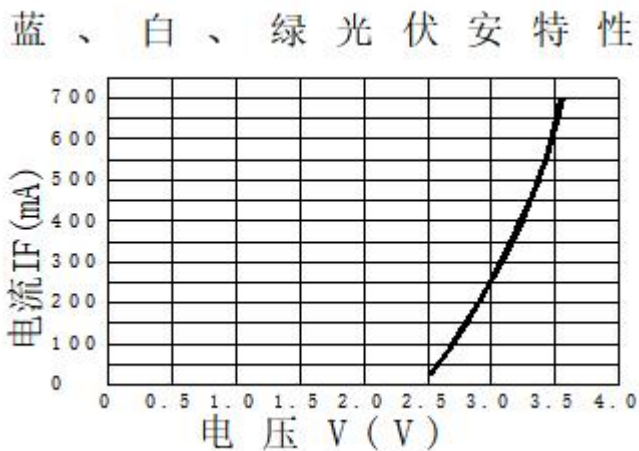

Figure4. Typical forward current vs. forward voltage

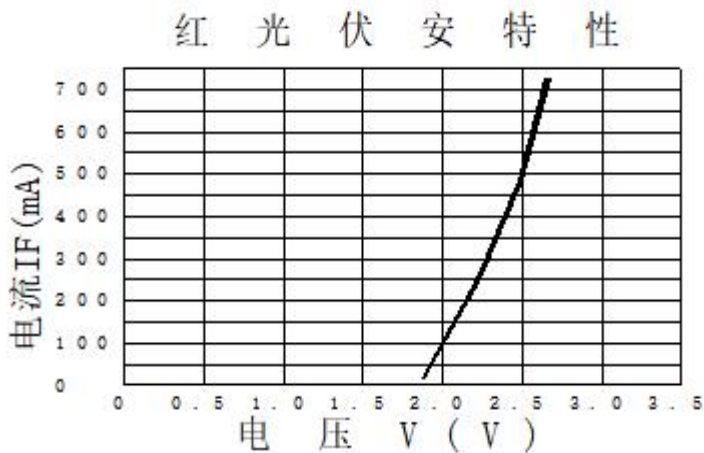

Figure5. Relative Intensity Vs. Ambient Temperature

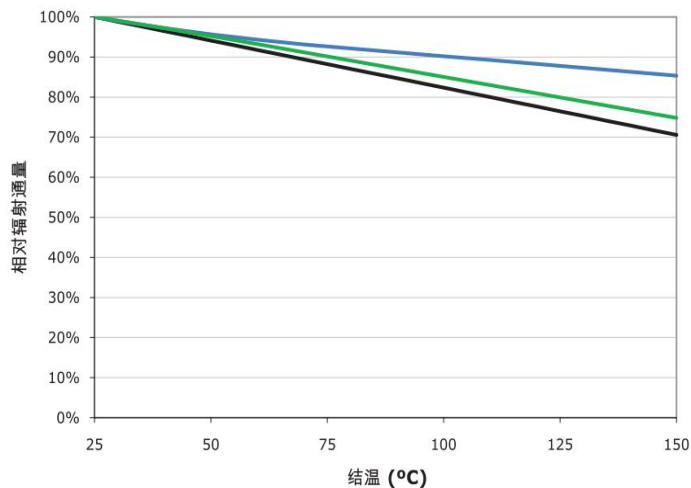
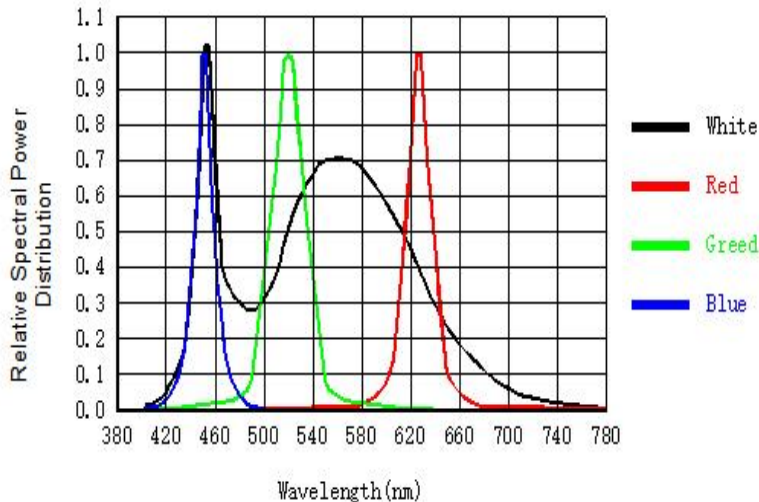
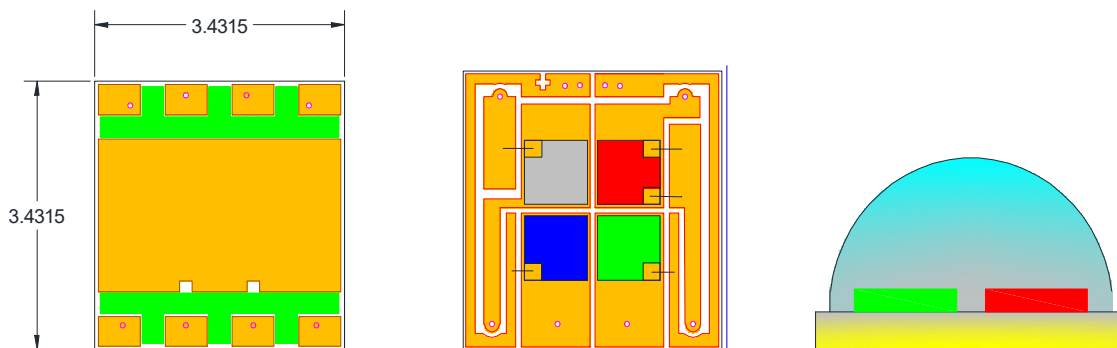

Figure6. Color Spectrum, Tj = 25°C, IF=150mA



1. Xdlumen does not recommend driving our LED arrays at low currents. Doing so may produce unpredictable results.
2. Products tested based on operation under DC(Direct current) with LED array mounted onto a heat sink with thermal interface material and Tc (case temperature) = 25°C. Base on Xdlumen test set up, values also depending on the thermal design and exposed environment to which the luminaire is subjected.

Product Packing Dimensions (Unit:mm)



Solder Pad Design (Unit:mm)

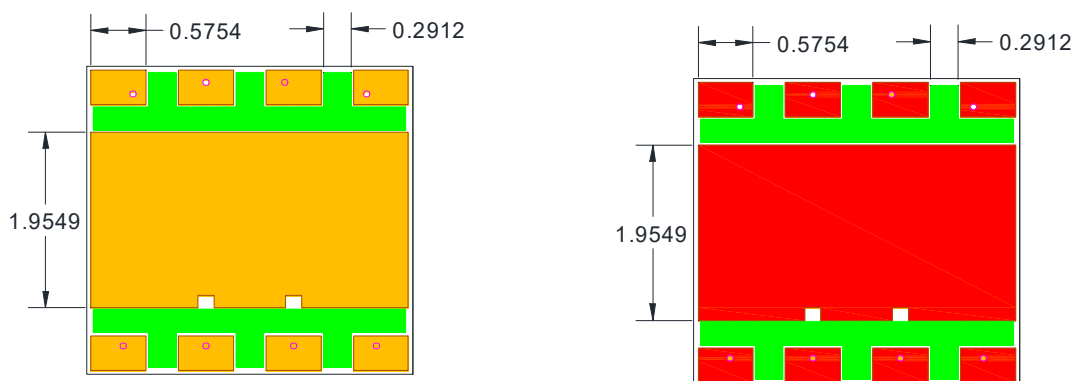

Recommended Copper Layout

Recommended Solder Pad

1.All dimension tolerance is $\pm 0.05\text{mm}$ unless otherwise noted.

Product Packing (Unit:mm)

1. The general packaging specifications: 1K/Reel,
2. Static bag packaging, Each package:1K

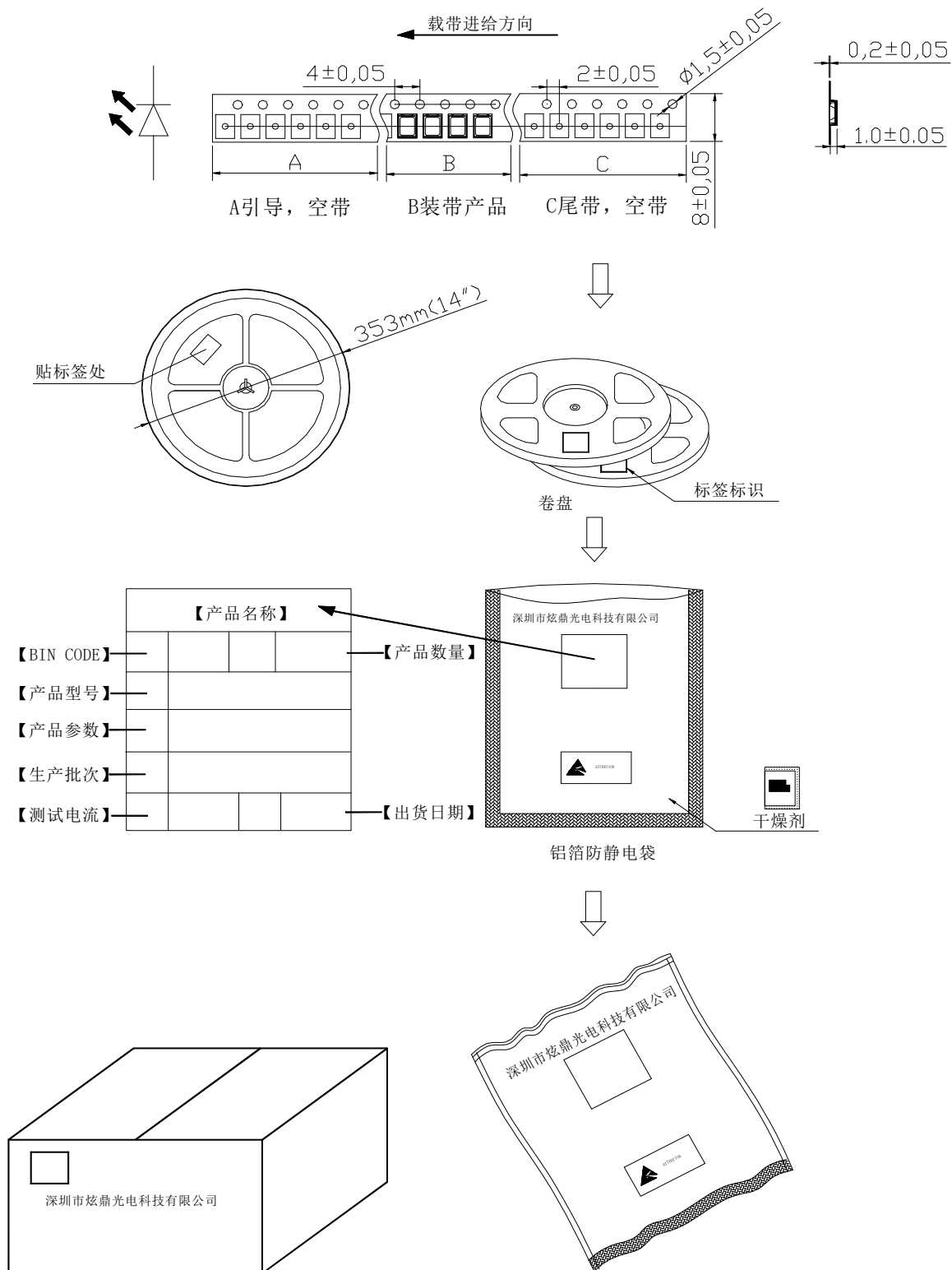

Application notes

1. Recommended current: 150*4mA

2. Moisture Proof Packing

- ✧ In order to prevent moisture absorption into SMT-LED during the transportation and storage, SMT-LED is packed in a moisture barrier bag. Desiccants and a humidity indicator are packed together with SMT-LED as the secondary protection. The indication of humidity indicator card provides the information of humidity within SMD packing. Humidity sensitive grade 2A

3. Storage

- ✧ Shelf life in original sealed bag at storage condition of <40°C and <60%RH is 6 months. Baking is required whenever shelf life is expired.
- ✧ Before unpacking, please check whether there is air leak in the packing bag. After bag opening, the SMT-LED must be stored under the condition < 30°C and < 50%RH. Under this condition, SMT-LED must be used (subject to reflow) within 24 hours after bag opening, and re-baking is required when exceeding 24 hours.
- ✧ For baking, place SMT-LED in oven at temperature 60°C±5°C and relative humidity ≤10%RH, for 24 hours.

4. Cleaning

- ✧ **Don't** use unspecified chemical liquids to clean the SMT-LED; the chemical could harm the SMT-LED. When washing is necessary, please immerse the SMT-LED in alcohol at normal room temperature for less than 1 minute and dry at normal room temperature for 15 minutes before use.
- ✧ The influence of ultrasonic cleaning on the SMT-LED depending on factors such as ultrasonic power and the way SMT-LED are mounted. Ultrasonic cleaning shall be pre-qualified to ensure this will not cause damage to the SMT-LED.

5. Electrostatic Discharge and Surge current

- ✧ Electrostatic discharge (ESD) or surge current (EOS) may damage SMT-LED.
- ✧ Precautions such as ESD wrist strap, ESD shoe strap or antistatic gloves must be worn whenever handling of SMT-LED.
- ✧ All devices, equipment and machinery must be properly grounded.
- ✧ It is recommended to perform electrical test to screen out ESD failures at final inspection.
- ✧ It is important to eliminate the possibility of surge current during circuitry design

6. Heat Management

- ✧ Heat management of SMT-LED must be taken into consideration during the design stage of SMT-LED application. The current should be de-rated appropriately by referring to the de-rating curve attached on each product specification.

7. Soldering

. Manual soldering by soldering iron :

- ✧ The use of a soldering iron of less than 25W is recommended and the temperature of the iron must be kept at below 315°C, with soldering time within 3 seconds.
- ✧ The epoxy resin of SMT-LED should not be in contact with tip of soldering iron.
- ✧ No mechanical stress should be exerted on the resin portion of SMT-LED during soldering.
- ✧ Handling of SMT-LED should be done when the package has been cooled down to below 40°C or less. This is to prevent the SMT-LED failures due to thermal-mechanical stress during handling.

8. Repair

- ✧ LED Should not be repaired in reflow, When repair is inevitable, a double-head soldering iron should be used .It should be confirmed in advance whether the characteristics of LEDs will or will not be damaged by repairing;

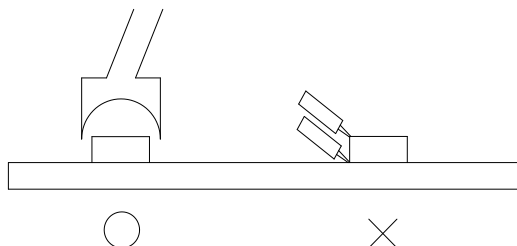

9. Handling precautions

- ✧ Compare to epoxy encapsulant that is hard and brittle, silicone is softer and flexible. Although its characteristic significantly reduces thermal stress, it is more prone to damage by external mechanical force . As a result, Special handling precautions must be observed during assembling using silicone encapsulated LED products, Failure to comply might leads to damage and premature failure of the LED.
- ✧ Handle the component along the side surface by using forceps or appropriate tools; do not directly touch or Handle the silicone lens surface, it may damage the internal circuitry

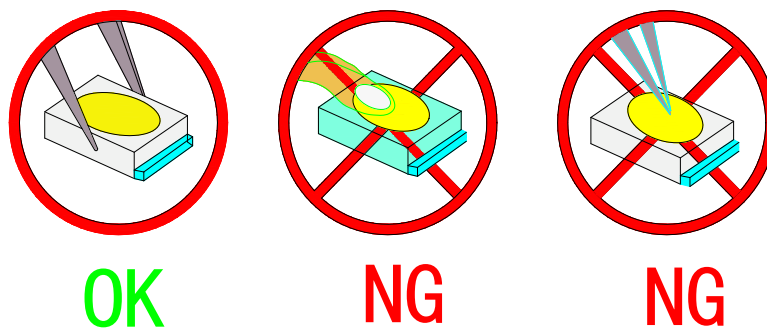

- ✧ The outer diameter of the SMD pickup nozzle should not exceed the size of the LED to prevent air leaks. The inner diameter of the nozzle should be as large as possible. A pliable material is suggested for the nozzle tip to avoid scratching or damaging the LED surface during pickup. The dimensions of the component must be accurately programmed in the pick-and-place machine to insure precise pickup and avoid damage during production.

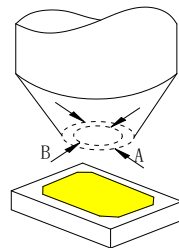

- ✧ Do not stack together assembled PCBs containing LEDs. Impact may scratch the silicone lens or damage the internal circuitry
- ✧ Not suitable to operate in acidic environment, PH<7

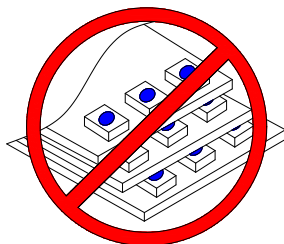

- ✧ LED operating environment and sulfur element composition cannot be over 100PPM in the LED mating usage material
- ✧ When we need to use external glue for LED application products, please make sure that the external glue matches the LED packaging glue. Additionally ,as most of LED packaging glue is silica gel, and it has strong Oxygen permeability as well as strong moisture permeability; in order to prevent external material from getting into the inside of LED, which may cause the malfunction of LED, the single content of Bromine element is required to be less than 900PPM,the single content of Chlorine element is required to be less than 900PPM,the total content of Bromine element and Chlorine element in the external glue of the application products is required to be less than 1500PPM
- ✧ When we need to use external glue for LED application products, we need to control the surface temperature under 55°C , As we mentioned at 9-6,the external glue contain Chlorine element, it can destroy the led.

SMT Reflow Soldering Instructions

◇ Suggested Welding Temperature Curve:

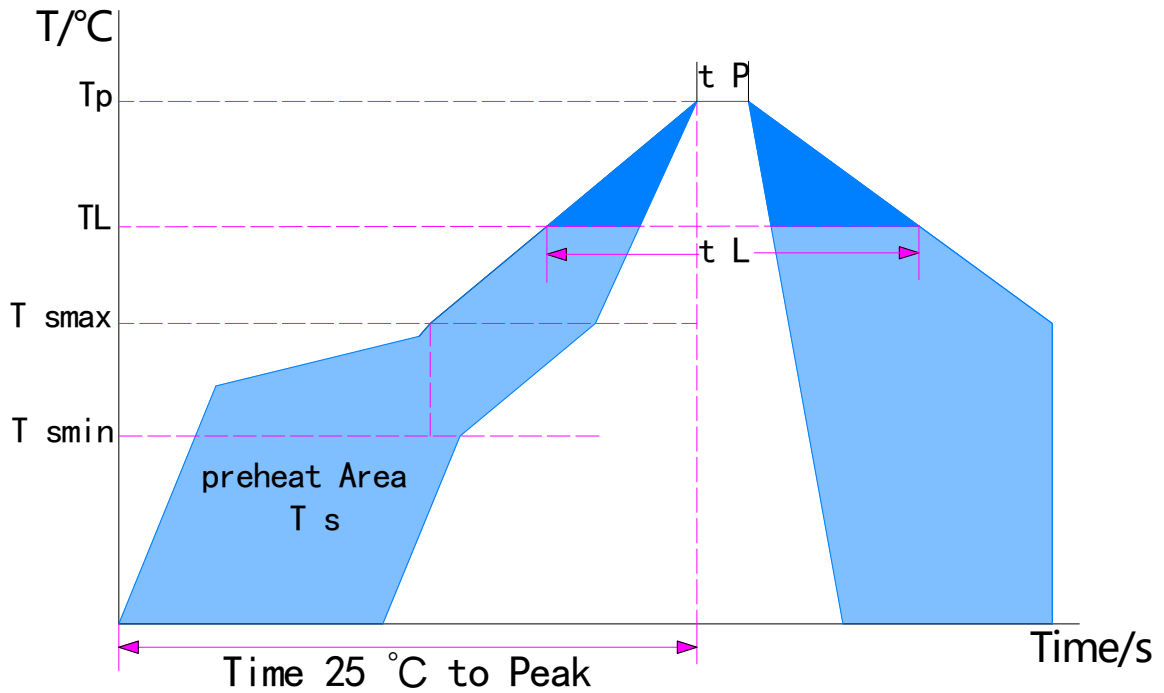

PROFILE FEATURE	LEAD-FREE ASSEMBLY
preheat minimumtemperature(min)	140~150°C
maximum temperature(min)	180-200°C
preheat time (T_{min} - T_{max})	60-120s
Ramp-Up Rate (T_L to T_p)	3°C/S max
Liquidus Temperature (T_L)	217°C
Time Maintained Above Temperature(T_L)	40S
Peak / Classification Temperature (T_p)	255°C
Time Within 5°C of Actual Temperature (t_p)	10-25s
Peak descent average speed	6°C/S max
Time 25°C to Peak Temperature	240S max

- ◇ Repair is not recommended when soldering is completed. Repair soldering is unavoidable, it must be checked and accepted after repairing, Preventing repair Destroy LEDS
- ◇ Reflow soldering should not be done more than two times;
- ◇ When soldering, do not put stress on the LEDs during heating;
- ◇ After welding, PCB can not be wrapped immediately, we should let the PCB board and the SMD-LED products cooling natural Term.

About Xdlumen

Xdlumen is one of the leading experts manufacturer of high power LED in China. We committed to providing environmentally friendly products to the solid-state lighting mark. Xdlumen LEDs are compliant to the European Union directives on the restriction of hazardous substances in electronic equipment, namely the RoHS Directive 2011/65/EU and REACH Regulation (EC) 1907/2006. Let's make light excellent.

For more information about Xdlumen please visit:

www.xdlumen.com

Contact US

6th floor, Building H, Jinchangda Industrial Zone, Shangwei, Zhangkengjing, Guanhu street,
Longhua District, Shenzhen, China

Tel: +86-755-23775517

Fax : +86-755-23775517

www.xdlumen.com